

Electric Eel® CABLE & TOOL SELECTION GUIDE

MAINLINE TOOLS & ACCESSORIES

All tools & accessories listed below are compatible with Electric Eel Models C, D-5, R, RF, 325, 800 and work with 8' and 10' dual cables (all types) and 5/8" and 3/4" continuous cables.

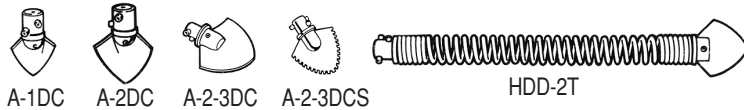

A-1DC A-2DC A-2-3DC A-2-3DCS HDD-2T

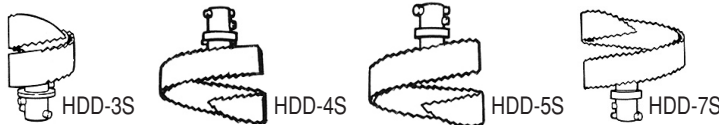

HDD-3S HDD-4S HDD-5S HDD-7S



U-3 U-4 U-6 U-4H UC3



HDD-U3 HDD-U4



EX-4A EX-6A EX-8A



HDD-3S-P HDD-4S-P HDD-4S-31/2-P HDD-5S-P



A-14DC A-6ADC A-13DC A-13-2DC

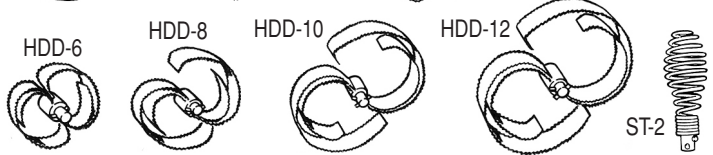

HDD-6 HDD-8 HDD-10 HDD-12 ST-2

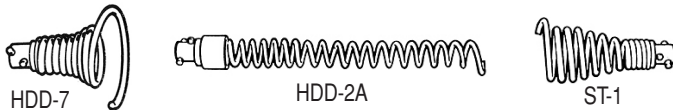

HDD-7 HDD-2A ST-1

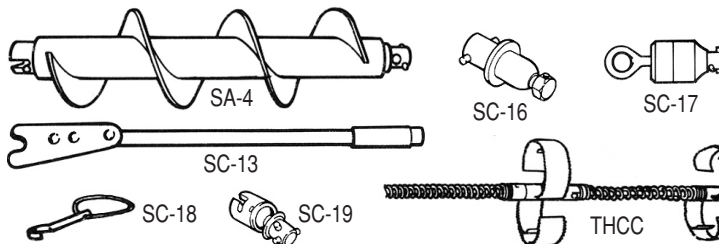

SA-4 SC-13 SC-16 SC-17 SC-18 SC-19 THCC

INITIAL OPENING TOOLS

- A-1DC 1 7/8" Diameter for 3" or larger pipeline
- A-2DC 2 3/8" Diameter for 4" or larger pipeline
- A-2-3DC 3" Diameter for 4" or larger pipeline
- A-2-3DCS 3" Ice chopping tool for 4" or larger pipelines
- HDD-2T 2 3/8" Spear point on 12" flexible spring for 4" or larger pipeline

HEAVY-DUTY ROOT SAW TOOLS

- HDD-3S For 3" pipeline
- HDD-4S For 4" pipeline
- HDD-5S For 6" pipeline
- HDD-7S For 8" pipeline

GREASE TOOLS

- U-3 For 3" pipeline (also available in Heavy duty)
- U-4 For 4" pipeline (also available in Heavy duty)
- U-6 For 6" pipeline (also available in Heavy duty)
- U-4H Heavier duty for 4" pipelines
- UC3 For 3" pipeline

FLEXIBLE SPRING TOOLS

- HDD-U3 12" Spring with U3 blade for 3" pipeline
- HDD-U4 12" Spring with U4 or HD blade for 4" pipeline

EXPANSION TOOLS

- EX-4A For 3" - 4" lines
- EX-6A For 4" - 6" Lines
- EX-8A For 6" - 8" lines

SLUDGE BUSTER TOOLS

- HDD-3S-P 2 3/8" Heavy duty sludge pusher for 3" pipelines
- HDD-4S-P 3" Heavy duty sludge pusher for 4" pipelines
- HDD-4S-31/2-P 3 1/2" Heavy duty sludge pusher for 4" lines
- HDD-5S-P 5" Heavy duty sludge pusher for 6" lines

FINISHING TOOLS

- A-14DC 3 1/2" Diameter tool for 4" or larger pipelines
- A-6ADC 5" Diameter for 6" or larger pipelines
- A-13DC For 4" conductor lines
- A-13-2DC For 3" conductor lines
- HDD-6 "S" Shaped for 6" lines
- HDD-8 "S" Shaped for 8" lines
- HDD-10 "S" Shaped for 10" lines
- HDD-12 "S" Shaped for 12" lines
- ST-2 Bulb shaped tool for 4" plastic pipeline

RETRIEVING TOOLS

- HDD-7 3" Tool for retrieving objects from pipeline
- HDD-2A Longer, thinner right hand wound retriever
- ST-1 Right hand wound retrieving tool

ACCESSORIES

- SA-4 Sand auger tool - Affix a spade-type tool for use on culverts under roadways
- SC-13 Feeding tool for use on "P" traps
- SC-16 Torque wrench adapter
- SC-17 Swivel cable puller for threading cable through pipeline
- SC-18 Spanner wrench for disconnecting cables/tools
- SC-19 Drop head adapter - provides swivel joint between cleaning tool and cable
- THCC Connector cable for connecting tools in tandem (tools not included)

Electric Eel® CABLE & TOOL SELECTION GUIDE

DRAIN LINE TOOLS & ACCESSORIES

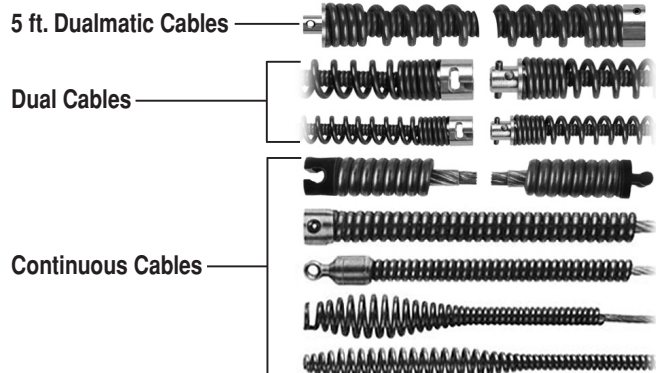
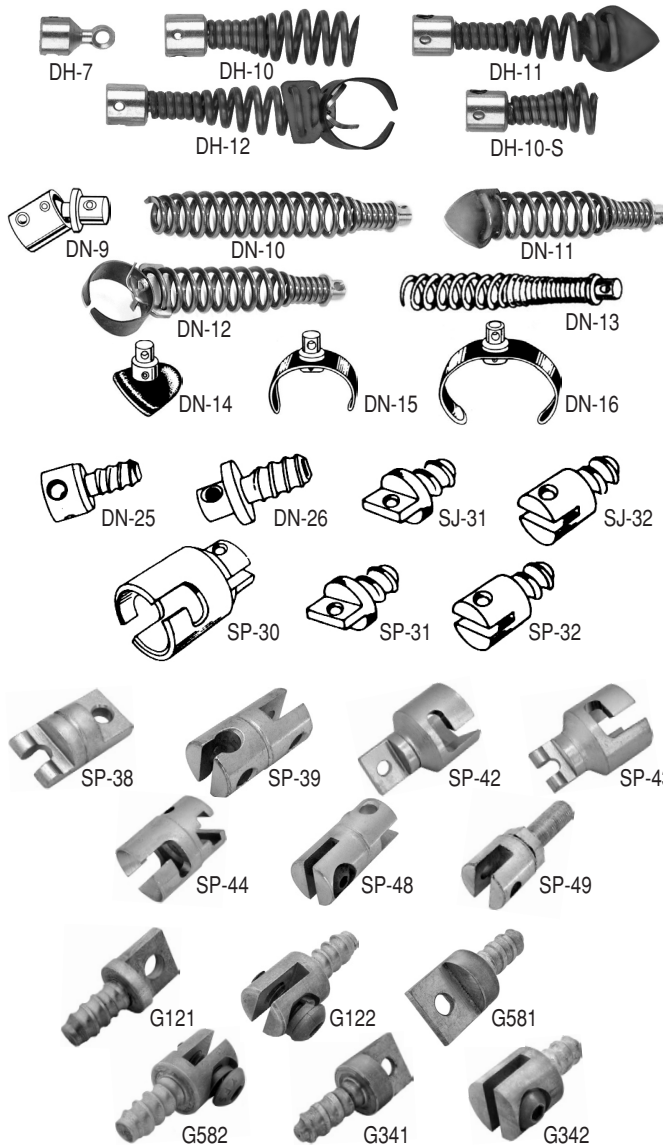

DH SERIES TOOLS

For use with 5/16" IC and 3/8" IC cables

- DH-7 Drop head adapter
- DH-10 General purpose tool
- DH-11 Drill point tool
- DH-12 Finishing/Grease tool
- DH-10-S Short general purpose tool

DN SERIES TOOLS

For use with 1/2" I.C. cables and 5DN sectional cable

- DN-9 Drop head adapter
- DN-10 General purpose tool
- DN-11 Drill point tool
- DN-12 Finishing/Grease tool
- DN-13 Retriever tool
- DN-14 Drill for 2"-3" lines
- DN-15 Clean up tool for 2" lines
- DN-16 Clean up tool for 3" lines

FITTINGS FOR ELECTRIC EEL 1/2", 5/8", 3/4" CABLES

- DN-25 Front fitting (female) 1/2" cable
- DN-26 Rear fitting 1/2" (male) cable
- SJ-31 Front (male) fitting 5/8" cable
- SJ-32 Rear (female) fitting 5/8" cable
- SP-31 Front (male) fitting 3/4" cable
- SP-32 Rear (female) fitting 3/4" cable
- SP-30 Tool adapter for 5/8" and 3/4" cable

SPECIAL ADAPTERS

NOTE: For use with OTHER brands of drain cleaning equipment

- SP-38 Adapts Electric Eel SP-30 tool adapter to Spartan* 5/8" or 3/4" Cable
- SP-39 Adapts Spartan* lead cable to Electric Eel SP-31 male fitting
- SP-42 Adapts Electric Eel dual tools to General Wire Spring* 3/4" cable
- SP-43 Adapts Electric Eel dual tools to Spartan* 5/8" and 3/4" cable
- SP-44 Adapts Electric Eel dual tools to Ridgid* 1 1/4" sectional cable
- SP-48 Adapts General Wire Spring* tools to SP-31 male fitting
- SP-49 Adapts Spartan* tools to SP-31 male fitting

CABLE FITTINGS

The following General Wire Spring* fittings can be adapted to Electric Eel Cables:

- G121 1/2" Male fitting
- G122 1/2" Female fitting
- G581 5/8" Male fitting
- G582 5/8" Female fitting
- G341 3/4" Male fitting
- G342 3/4" Female fitting

CABLES FOR EVERY NEED

- 5 ft. Dualmatic Cables (Model N Only)
- Self-feed Dual Cables for 3"-10" lines available in regular, heavy-duty and municipal
- J Cable 6J (7/8" x 6 ft.) Dual Cable for use in 2"-3" lines (Model C Only)
- Tri-Max 3/4" or 5/8" cable with slot or keyhole end fittings to fit most drain cleaning machines
- 1/2" Aircraft Wire Reinforced Cables with front & rear fittings (available in No_Core)
- Aircraft Wire Reinforced Cables (5/16" and 3/8") for use with Drop Head series tools
- Expanded End Aircraft Wire Reinforced Cables with bulb end & no rear fittings (5/16", 3/8")
- Expanded End Cables to negotiate pipe traps & drain cross bars (1/4", 5/16", 3/8")

*Spartan, Ridgid, General Wire Spring are trademarked names.

For More Information, Call 800-833-1212 or Visit Our Web Site at www.electriceel.com



Electric Eel®
DRAIN CLEANING TOOLS FOR PROFESSIONALS

Note: Always refer to operator's manual and safety instructions before operating any drain and sewer cleaning equipment.

ELECTRIC EEL MANUFACTURING CO., INC.
501 W. Leffel Lane, Springfield, Ohio 45501-9985
937-323-4644 Toll-Free: 800-833-1212 FAX: 937-323-3767
E-mail: info@electriceel.com www.electriceel.com LT-25